

# Doppelboden

WEISS Doppelbodensysteme GmbH  
Bänglesäcker 6+9; 73527 Lindach  
[www.weiss-doppelbodensysteme.de](http://www.weiss-doppelbodensysteme.de)

WEISS



# „Made in Germany“



**Baden  
Württemberg:**

Heimat der Tüftler und  
Ingenieure

Hochqualifizierte  
Mitarbeiter

Präzision als Hobby

Qualität als Maßstab

# Fakten und Zahlen

- 37 Jahre Produktion von Doppelböden
- „Made in Germany“
- Innovativ
- Schnelle Lieferung
- Ausgeklügelte Logistik
- Weltweite Lieferung



# Normen und Prüfungen

- Load Bearing according to DIN EN 12825
- ISO 9001:2008 certified
- LEED
- F30: DIN EN 13501
- E1
- FSC
- IBR Seal
- Emmission test reports



# Mitglied

**BVS: Bundesverband Systemböden**



**VIRZ: Verband innovatives Rechenzentrum**



**ECO: Verband der deutschen Internetwirtschaft**



# Wo Doppelboden Warum Doppelboden

Technische Räume



Büro Gebäude



# So weit so gut

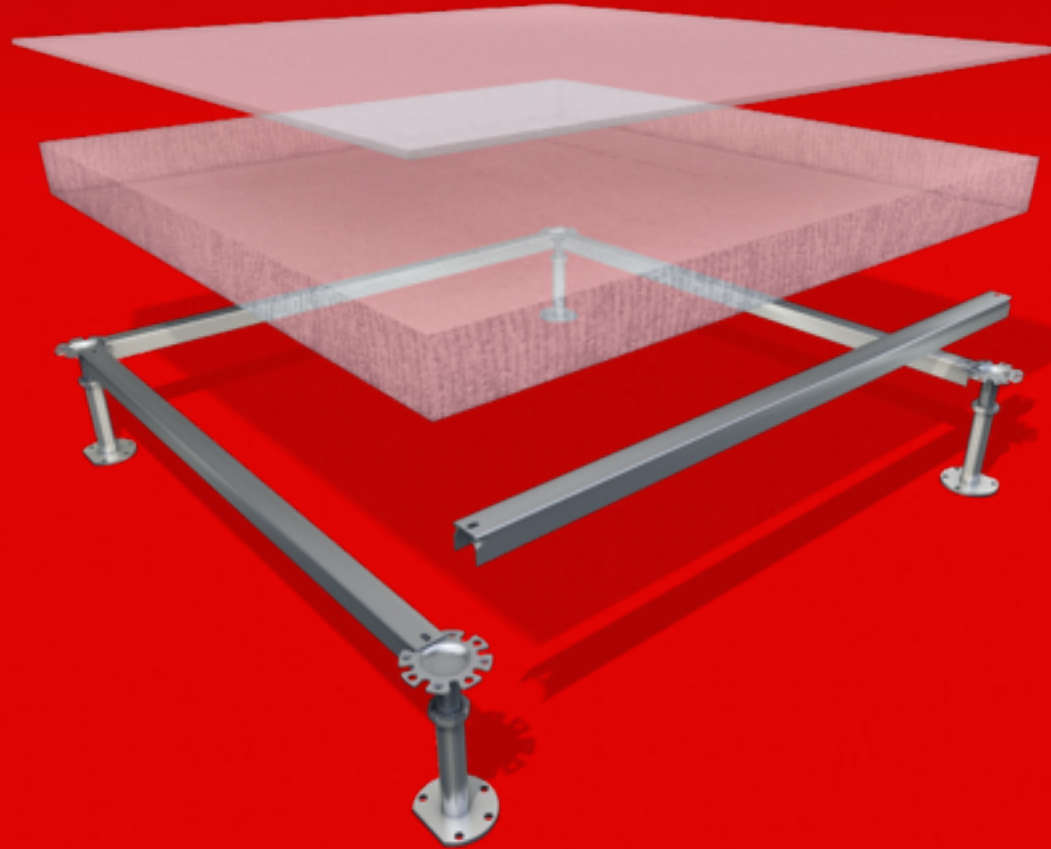

# Bedarfsgesteuerte Luftmengenregulierung



- Automatic opening and closing depending on heat load



# Demand controlled ventilation panel



- Automatic opening and closing depending on heat load

# Luft bei Bedarf

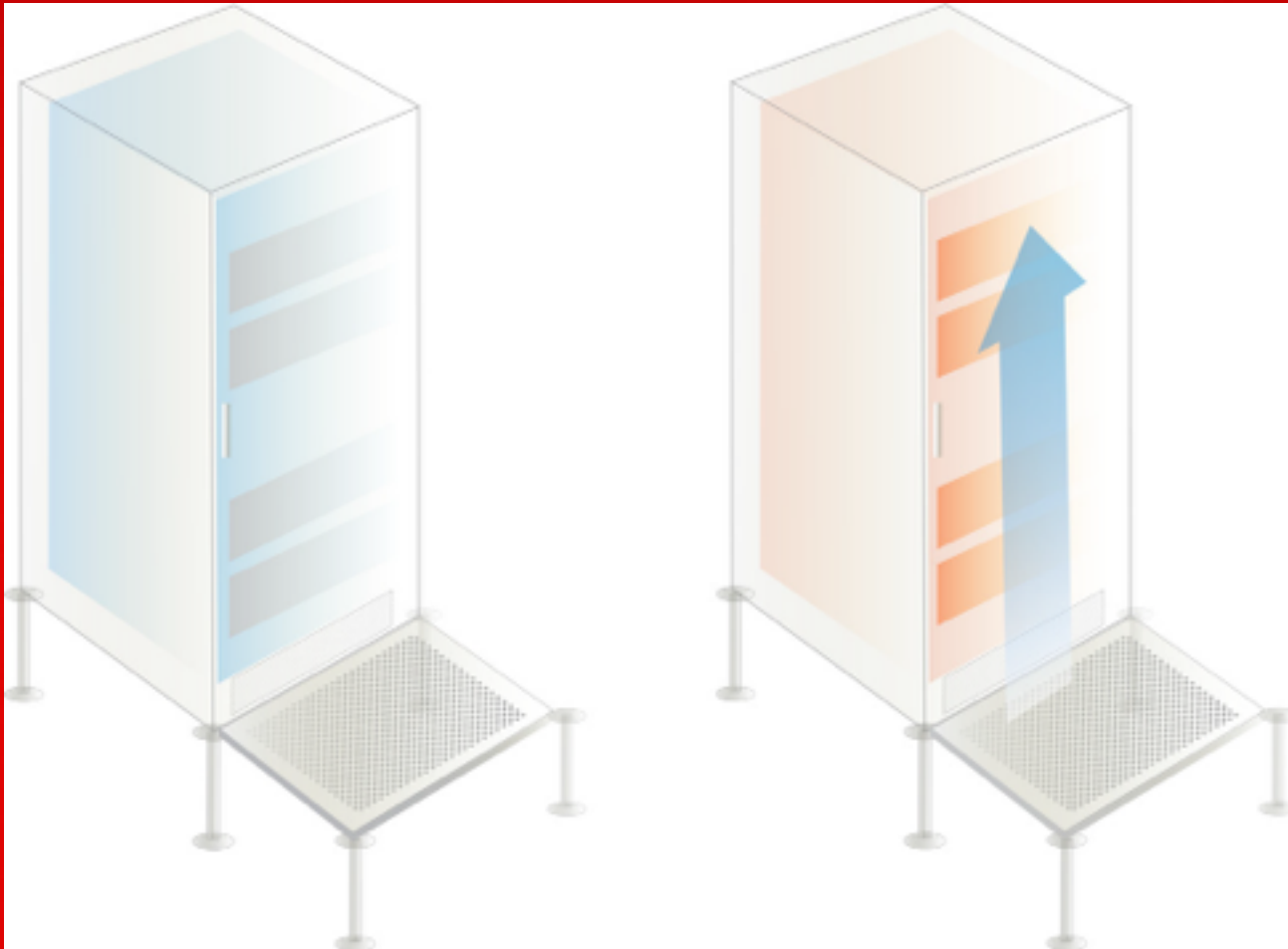

# Noch mehr Bedarf

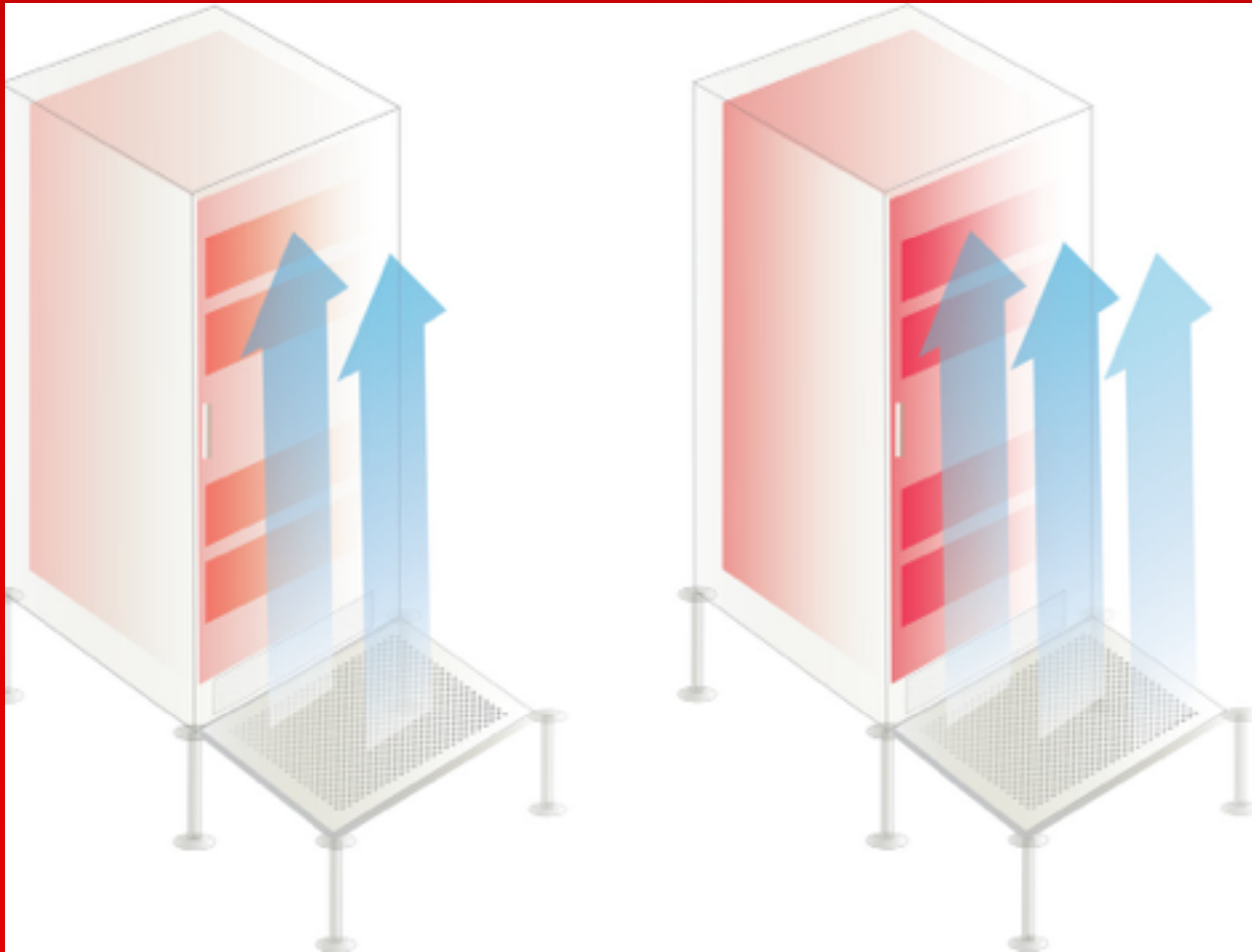

# on the job

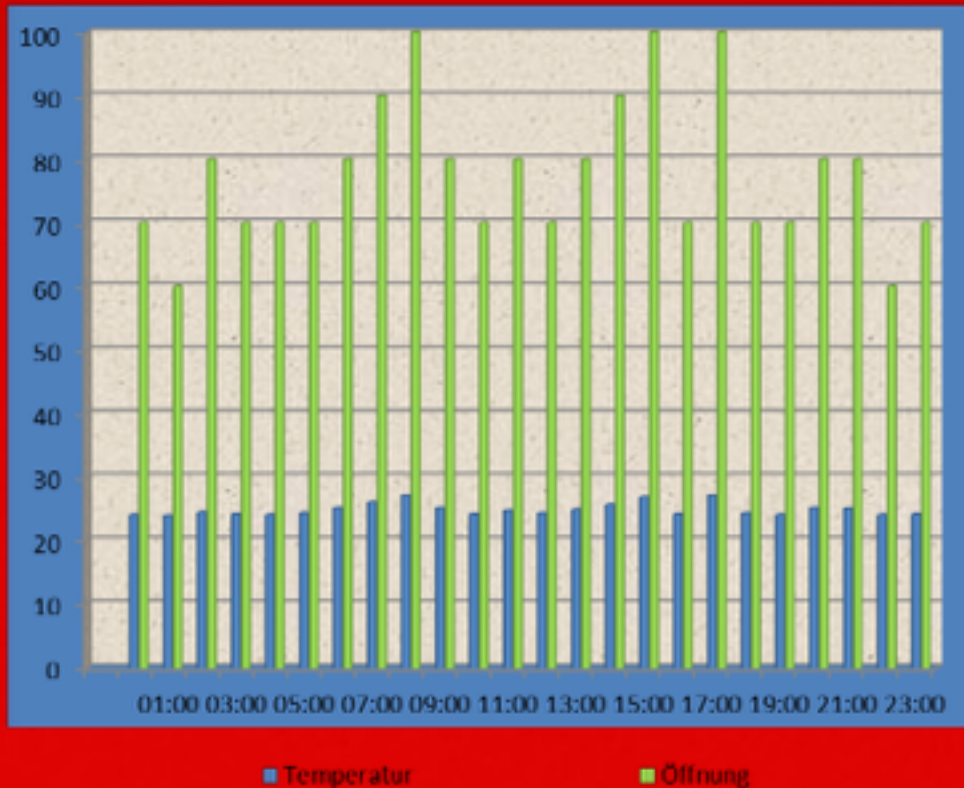

# ROI EcoLogic Panel

Rechenleistung  
pro Rack in kW

3,0

Durchschnittliche Auslas-  
tung in %

75,00%

Plattenpreis in €

350,00 €

Strompreis in €

0,15 €

**Ersparnis pro Jahr**

328,50 €

---

**ROI in Monaten**

**12,79**

# Kapazität

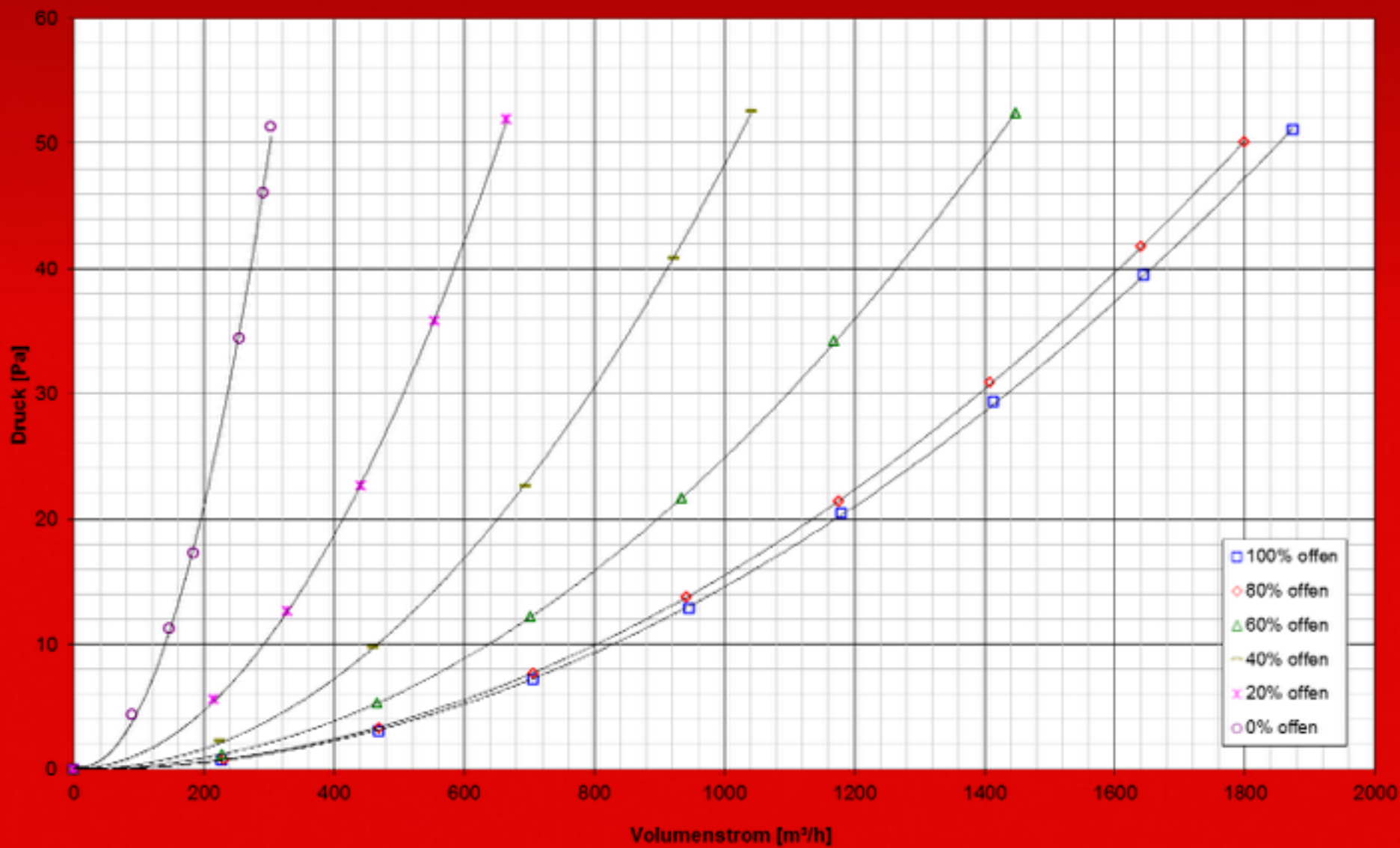

Jet<sup>®</sup>  
panel



Jet<sup>®</sup>  
panel





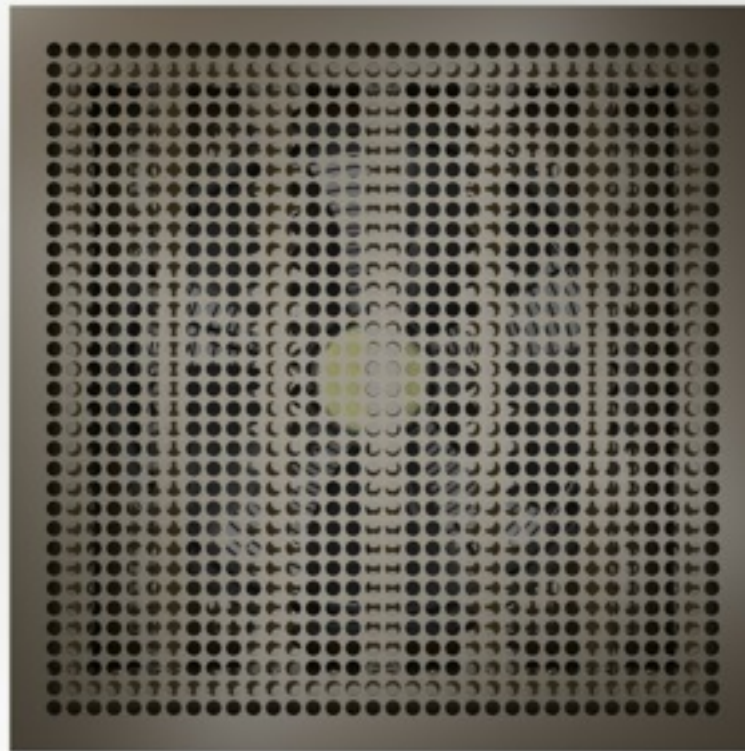

# Luftführung mit Sidecooler

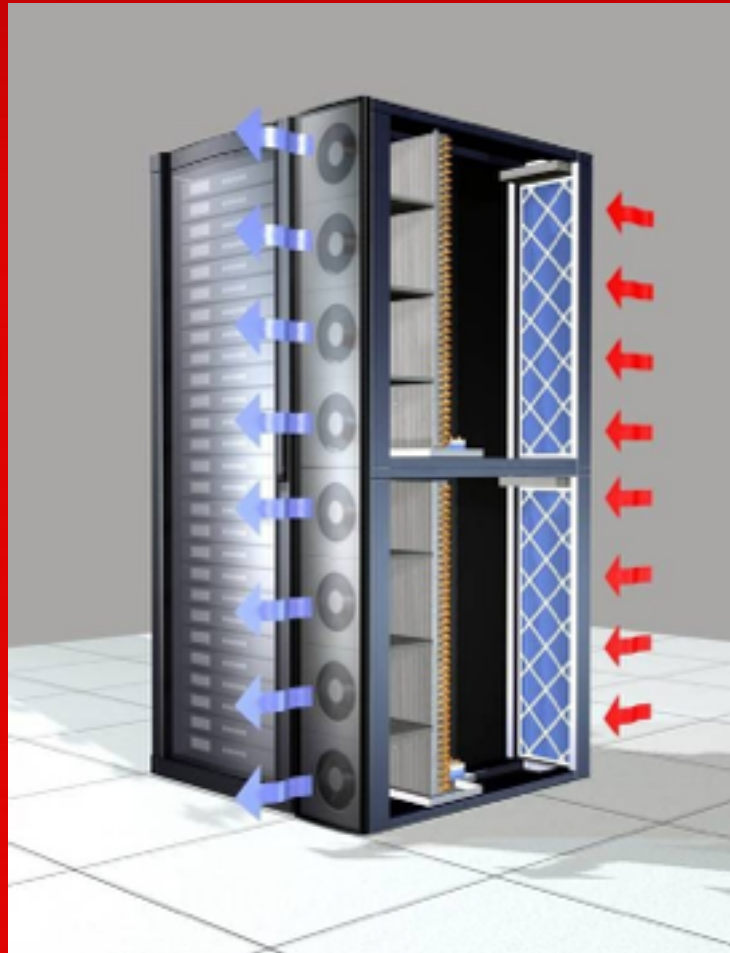

# HydrLogic panel

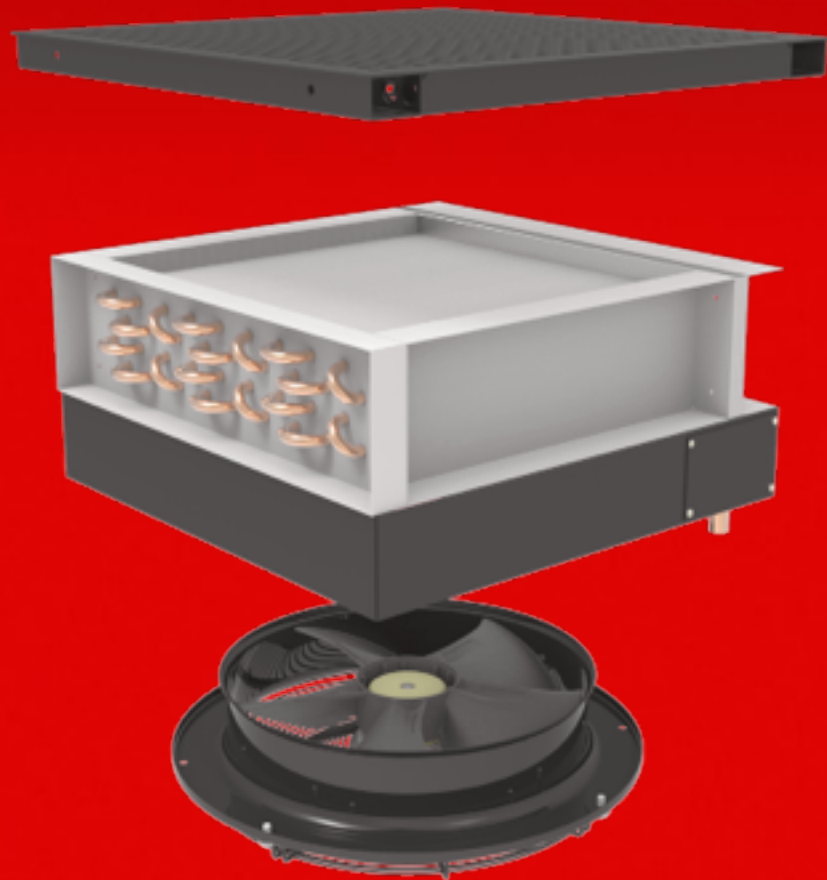

# Hydr Logic panel



# Hydr Logic panel

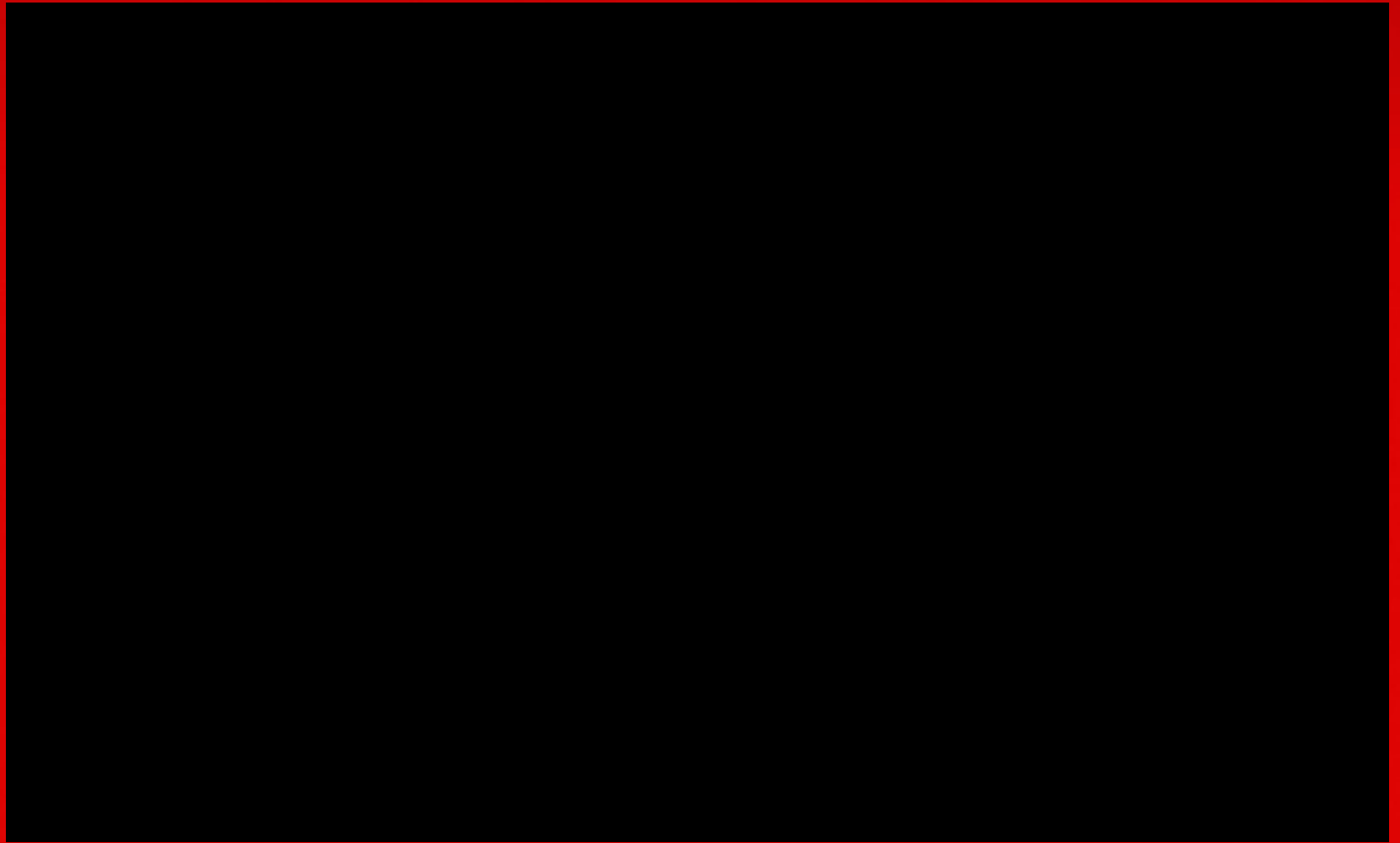



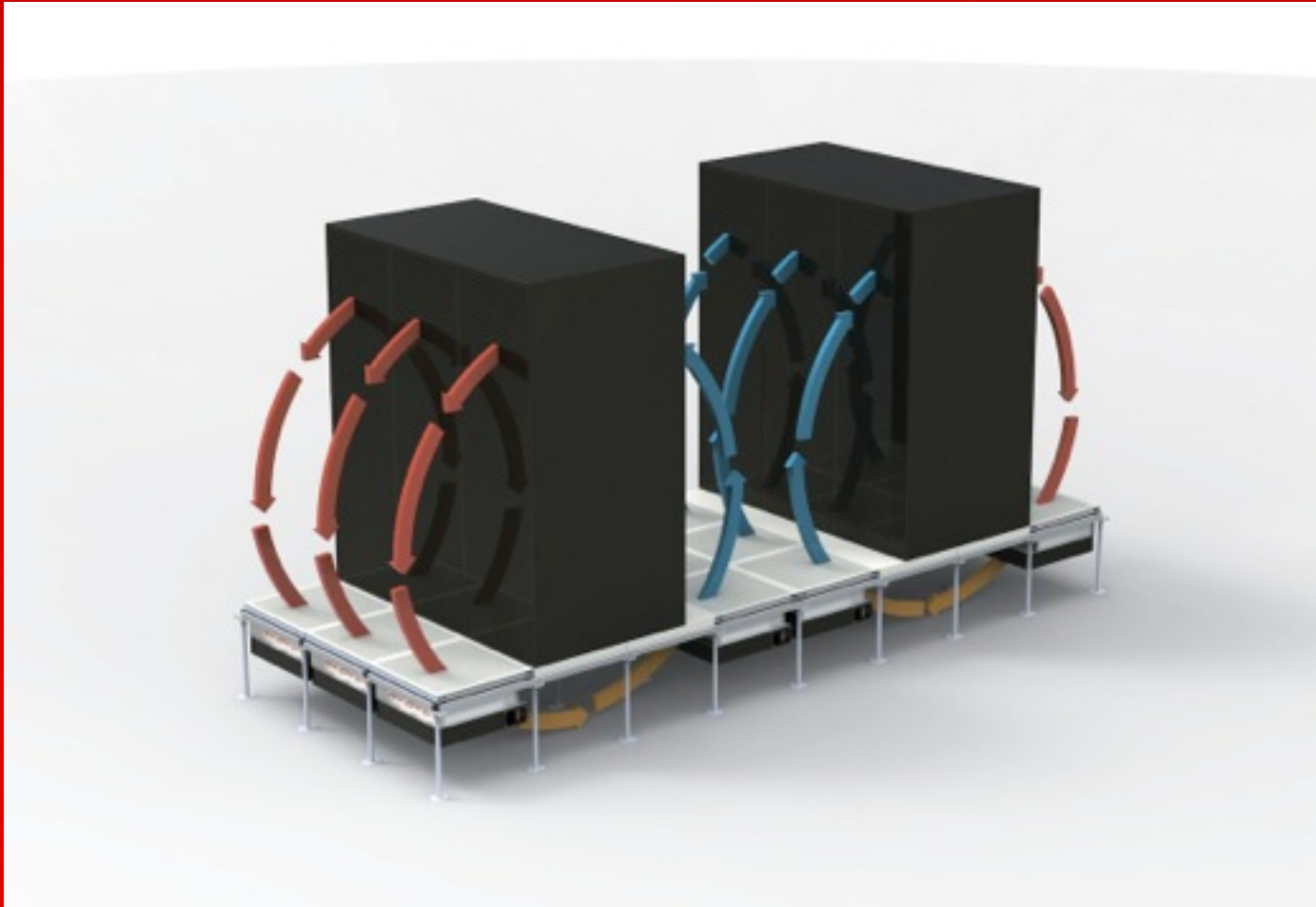

# MicroLogic Panel

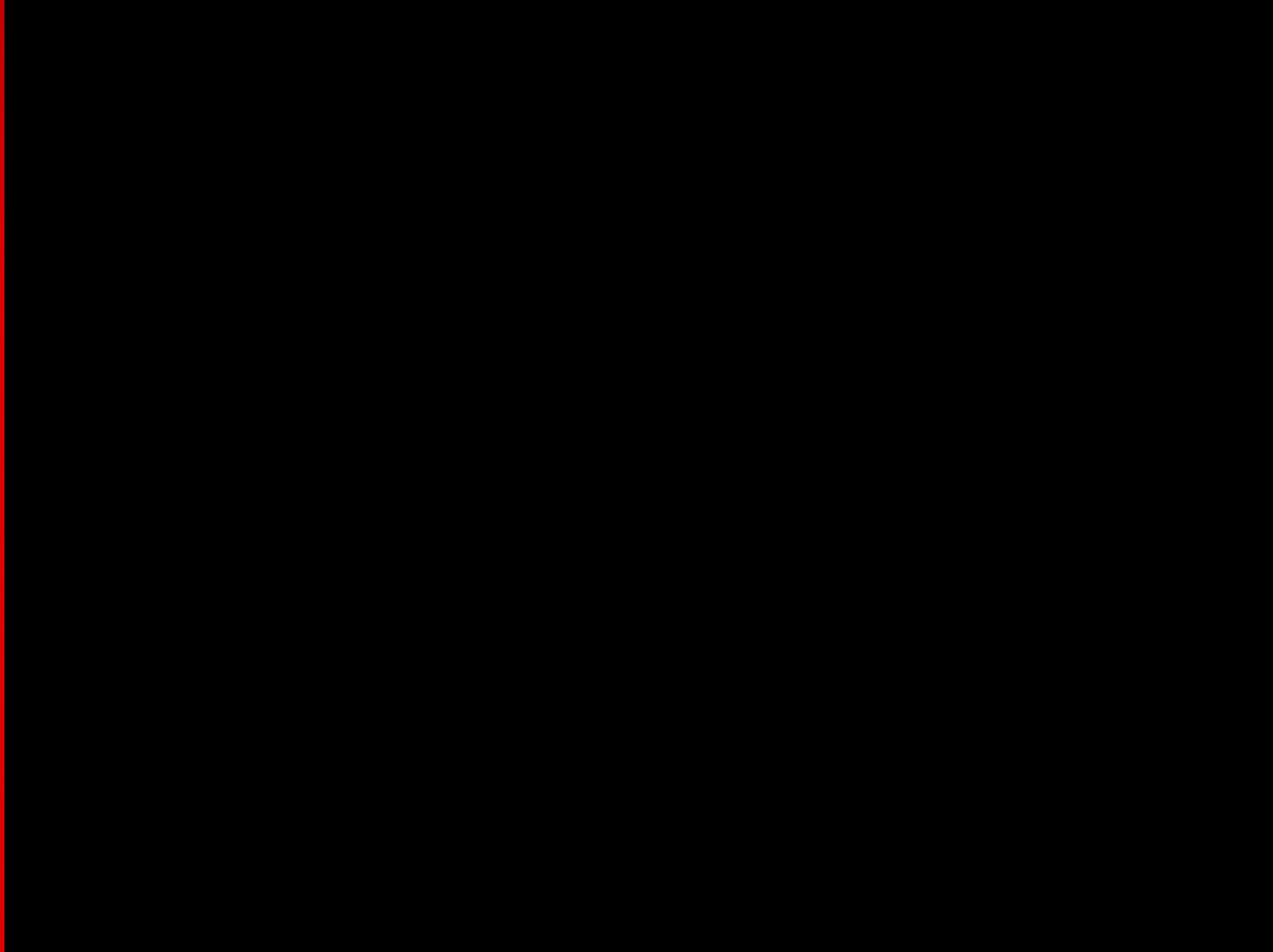



# MicroLogic Panel



# MicroLogic Panel



# Film ab

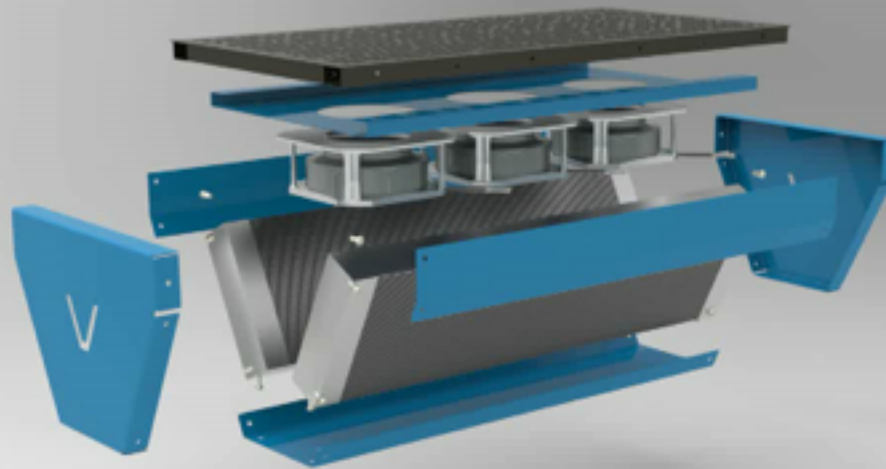

# HydroLogic Panel V

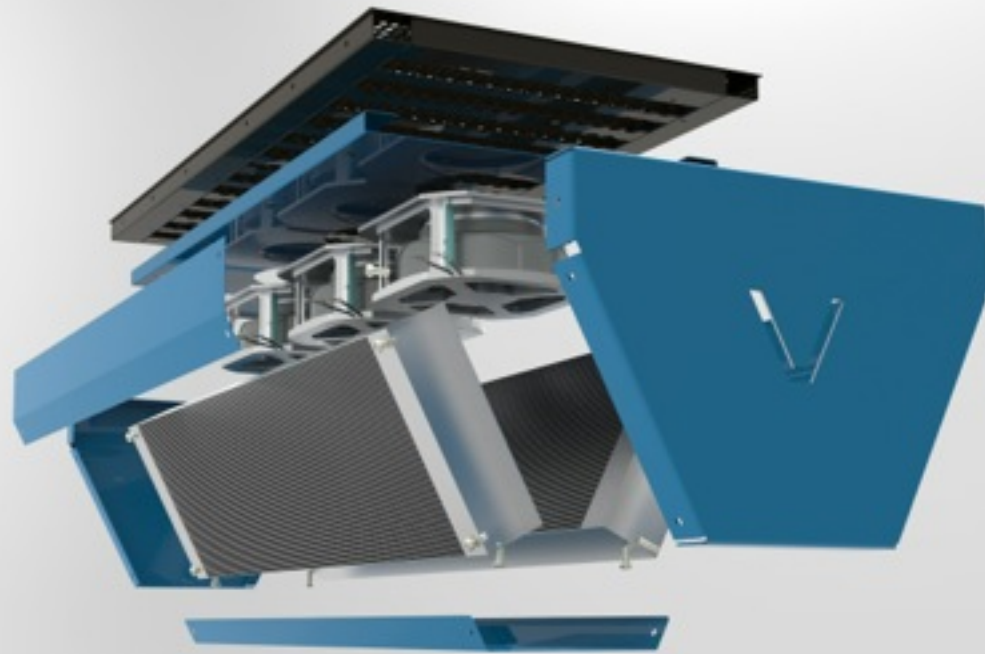

# Hydrologic Panel V



Passend für alle gängigen Doppelböden  
600 x 1200 x 450 mm

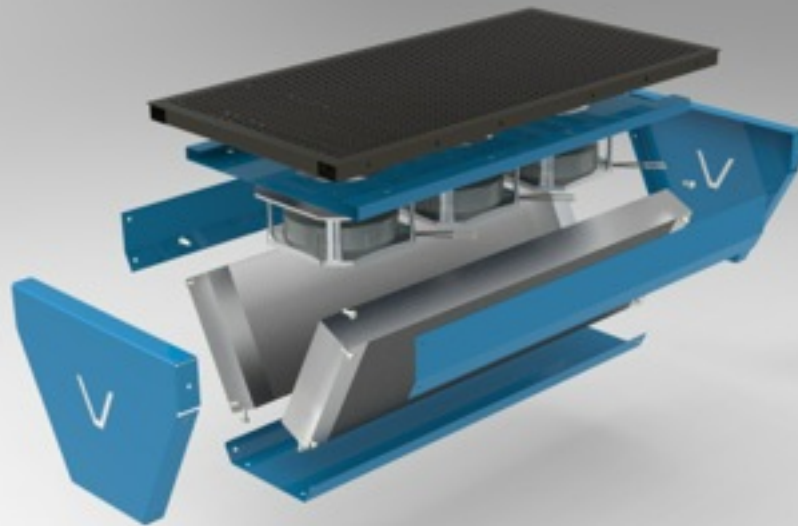

# Für Kaltgang und Warmgang

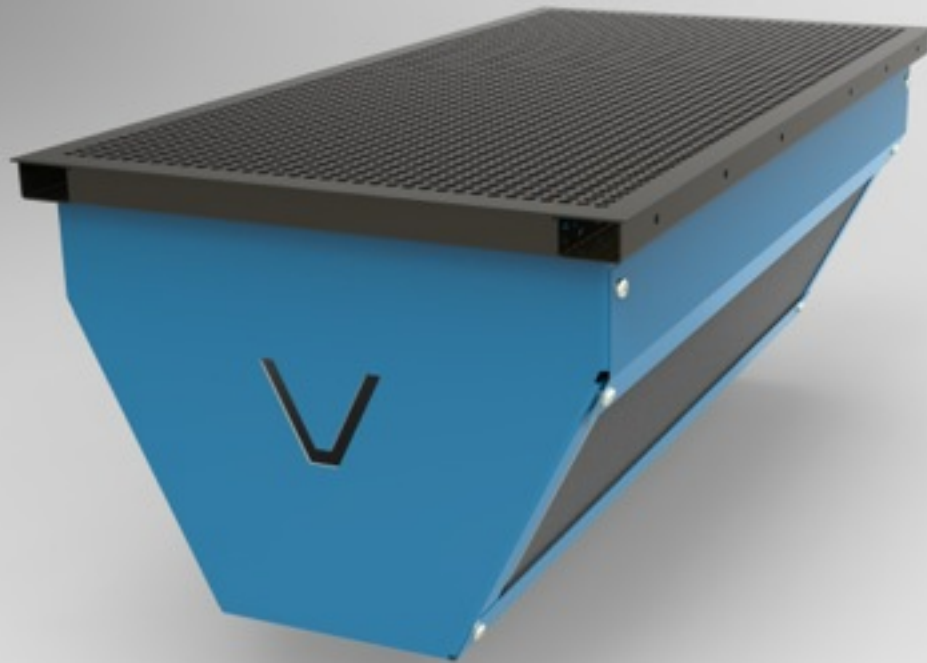

# Doppelbodenplatte mit voller Funktion 5-10 KN Punktlast

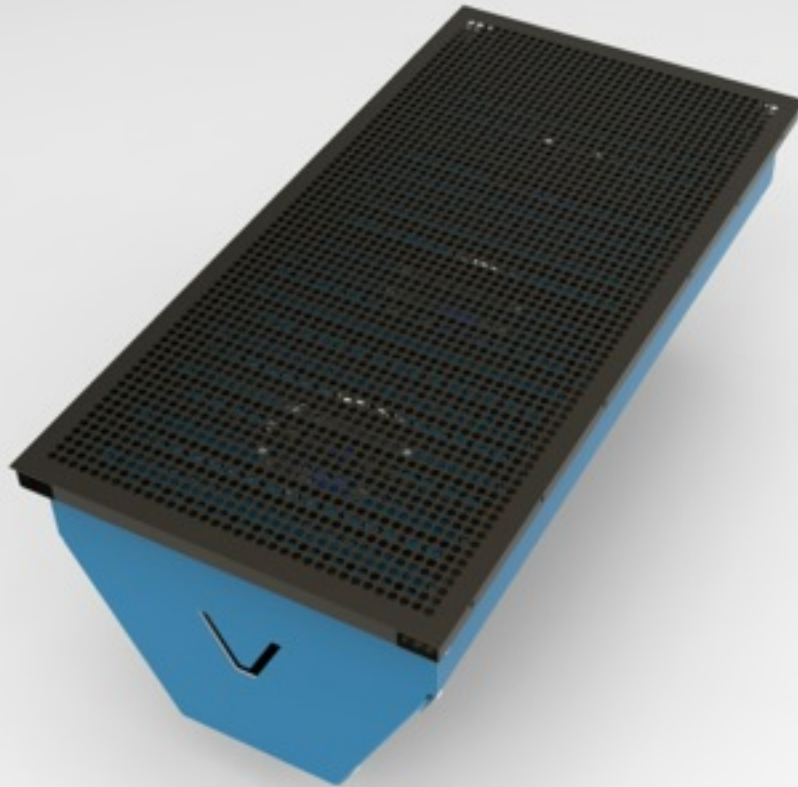



# Application CONTAIN RZ

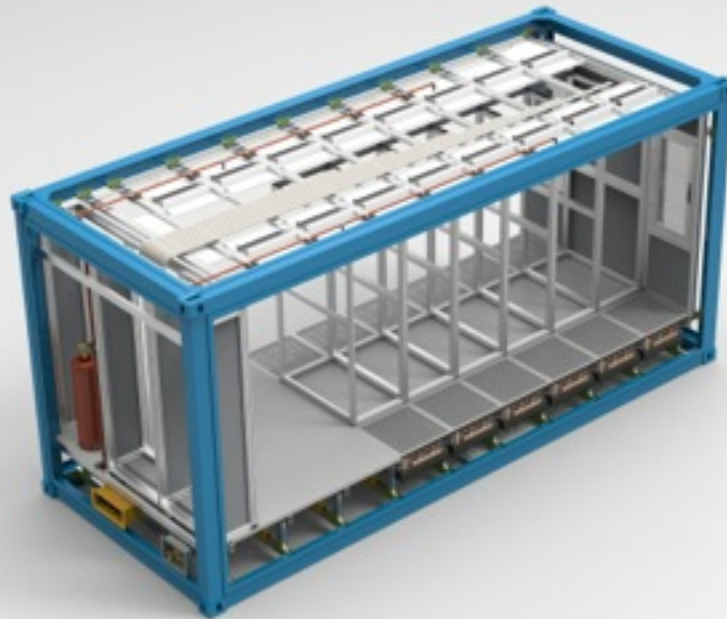

# Impressionen Fujitsu Forum 2012



# Impressionen Fujitsu Forum 2012



# Impressionen Fujitsu Forum 2012

